



**COSTRUZIONE APPARECCHIATURE ELETTRONICHE - OLEODINAMICHE - INDUSTRIALI**

42028 - POVIGLIO - (R.E.) - Via Parma, 59 - ITALIA

Tel. (0522) 960050 (r.a.) - Tlx. 530021 AINDRE I - Fax (0522) 960259



## **ZAPIMOS H0 200A**

### **OPERATING HANDBOOK AND**

### **FUNCTION DESCRIPTION**



# CONTENTS

	Page
<b>1 General characteristics .....</b>	<b>3</b>
1.1 Technical specifications .....	3
1.2 General scheme .....	3
1.3 Description of operation .....	4
1.4 Control unit characteristics .....	5
1.4.1 Potentiometer and inductive transducer for speed control (motor voltage) .....	5
1.4.2 Microswitches .....	5
1.5 Running direction: definition .....	6
1.6 General notes and precautions  .....	6
1.7 Susceptibility and electromagnetic emission  .....	7
<b>2 Installation .....</b>	<b>8</b>
2.1 Positioning and thermal dispersion .....	8
2.2 Choosing connection cabling .....	8
2.3 Contactors .....	8
2.4 Fuses .....	8
2.5 Arc suppressers .....	9
2.6 Dimensions .....	10
2.7 Mechanical drawing with contactors .....	11
<b>3 Connectors .....</b>	<b>12</b>
3.1 Connectors position .....	12
3.2 Connectors description .....	12
3.3 Power connectors description .....	13
<b>4 Programming by console .....</b>	<b>14</b>
4.1 Setting by console .....	14
4.2 Programming console .....	14
4.3 Console functions chart .....	15
4.4 MODEL: configuration mode .....	16
4.5 OPTION: configuration mode .....	17
4.6 PARAMETERS: configuration mode .....	20
4.6.1 H0 settings .....	20
4.7 TESTER menu: description .....	22
4.8 SAVE PARAM menu: description .....	24
4.9 RESTORE PARAM menu: description .....	25
4.10 ALARMS menu: description .....	26
4.11 PROGRAM VACC function: description .....	27
4.12 MOTOR DATA function: description .....	28

6.3.2	Power configuration .....	39
6.4	Standard H0 with by-pass .....	40
6.4.1	Cabling connection .....	40
6.4.2	Power configuration .....	40
6.5	Standard H0 with general contactor .....	41
6.5.1	Cabling connection .....	41
6.5.2	Power configuration .....	41
6.6	H0 autostop .....	42
6.6.1	Controls connection .....	42
6.6.2	Power configuration .....	42
6.7	H0 : Europe type quick inversion connection .....	43
6.7.1	H0 autostop IRE .....	43
6.7.2	H0 standard IRE .....	44
6.8	Power configuration with 3 cables series motors .....	44
6.8.1	With contactors .....	44
6.8.2	With forth braking cable and standard contactors .....	44
6.9	Power configuration with permanent magnet motors .....	44
6.10	Guide drawing for pallet trucks connection .....	45
6.11	Optional fuse-keeper board .....	46
7	Periodic maintenance to be repeated .....	47
8	Reccomended spare parts .....	48

 = Information provided within paragraphs marked by this symbol are absolutely important in view of ensure safety.

### SIGNATURE TABLE

COMPANY DEPT. SERVICES	MANAGEMENT EXECUTIVE	
ENGINEERING SECTION EXECUTIVE		
EXPORT MANAGER		

# 1 GENERAL CHARACTERISTICS

## 1.1 TECHNICAL SPECIFICATIONS

Operating voltage: .....	type model 24V
.....	type model 36V
Maximum current rating (1 min): .....	230Amps (180Amps)*
Booster current rating (3 seconds): .....	260Amps (210Amps)*
1 Hour Current ratings: .....	80Amps (60Amps)*
Drop Voltage with I=75Amps: .....	250mV (500mV)*
Frequency: .....	16KHz
Motor Maximum power: .....	1.5Kw(24V) 2,2Kw(36V)
Type of motors required: .....	DC series excited
Switching device: .....	MOSFET
Control device: .....	12MHz 8bit microprocessor
Maximum room temperature: .....	+40°C
Minimum room temperature: .....	-25°C
Relative humidity range: .....	20% - 95%
Protection degree: .....	IP20
Insulation AC: .....	500V
Weight (without contactors): .....	1.03 Kg

\* = 180Amps version

## 1.2 GENERAL SCHEME

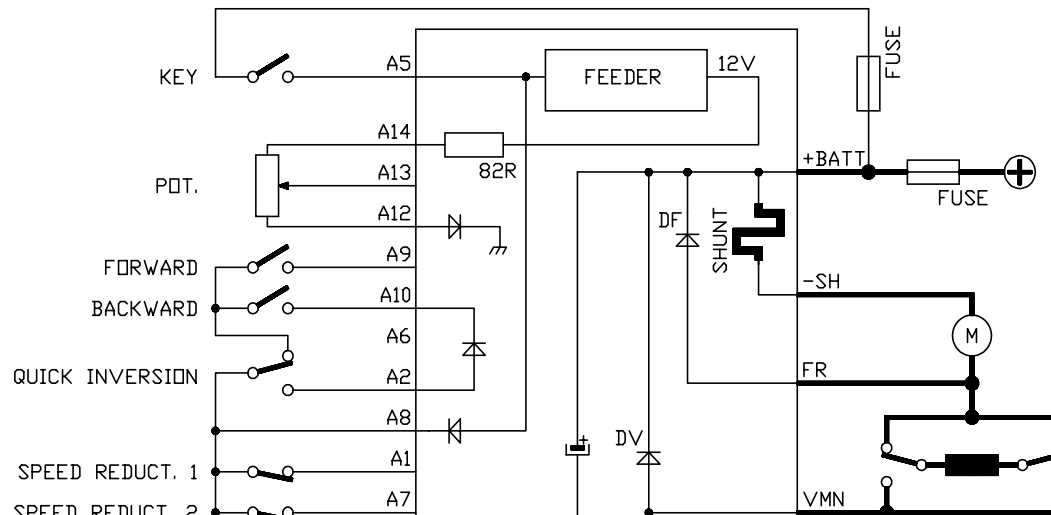

### 1.3 DESCRIPTION OF OPERATION

- Two configurations are available:
  - 1) AUTOSTOP configuration: releasing forward running, an adjustable braking mode is automatically accomplished by the device.
  - 2) STANDARD configuration: electric braking is available only inverting running direction; anyway you can use an auxiliary output for the electrobrake or by-pass or general contactor.
- By console all adjusting and option-configuring parameters range is programmable (see chapter 4).
- Diagnostic led placed on console connector.
- Motor plugging electric braking; braking intensity controlled via current.
- Complete and broad diagnosis on each chopper's element: any functional irregularity or component's fault is detected, displayed or revealed and cause a safety procedure start (running halts).
- Quick inversion: activated with an appropriate safe micro, if you're running forward. It consists of a strong braking and consequent start in backward direction with constant speed.
- Speed reduction with ohmic drop compensation. You can choose within 2 different operating modes:
  - 1°: both speed reductions are selected the slower prevails.
  - 2°: both speed reductions are selected, a 70% of slower speed is provided.
- A permanent magnet motor can be used changing programming setting for a correct handling.
- You can handle electro-brake in standard configuration.
- Acceleration stroke programmable
- Accomplished in conformity to 86/663 rules referring to points 9.7.3.5.5 and 9.7.3.1.7
- Accomplished in conformity to DRAFT PREN 1175 rules with reference to points 5.9.3, 5.9.4, 5.9.5, 5.13, 5.14, 5.15.

## 1.4 CONTROL UNITS CHARACTERISTICS

### 1.4.1 Potentiometer and inductive trasducer for speed control (motor voltage)

Potentiometer features

- minimum resistance: 500 ohm (25mA)
- maximum resistance: 20 Kohm (1mA)
- min sensible signal level:  $0.6 \div 2V$
- max. sensible signal level:  $0.6 \div 10V$
- Potentiometer signal range (PEDAL TYPE ON/OFF) is to be settled through programming console. Then, through PROGRAMM VACC function, minimum and maximum signal is taken in.

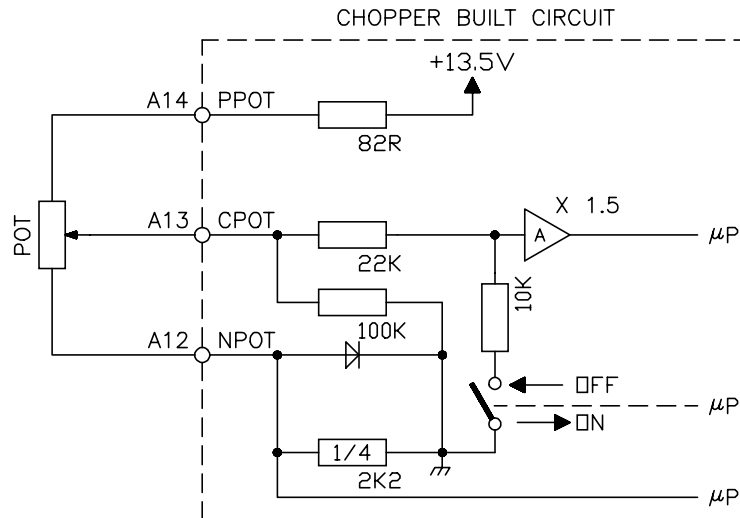

PEDAL TYPE = ON range 0.6 to 10V.

PEDAL TYPE = OFF range 0.6 to 3.4V.

- NPOT pin voltage is continuously tested by microprocessor for link detection confirm. If this test fails then the chopper arises WIRE PEDAL KO alarm, and it enters a blocked status until linking is correctly established.

**WARNING:** be careful to connect potentiometer negative to NPOT pin, not to Battery negative, as in this case alarm is issued and chopper block take place.

### 1.4.2 Microswitches features

- Their contact resistance shall be lower than  $0.1\Omega$ , leakage current rating lower than 100 mA.

## 1.5 RUNNING DIRECTION DEFINITION

According to PREN 1175 rules on guided machines with tiller and safety quick inversion button (used to prevent operator squashing), microswitches cabling for running direction and quick inversion ought to be done in respect of running direction definition given as shown below.

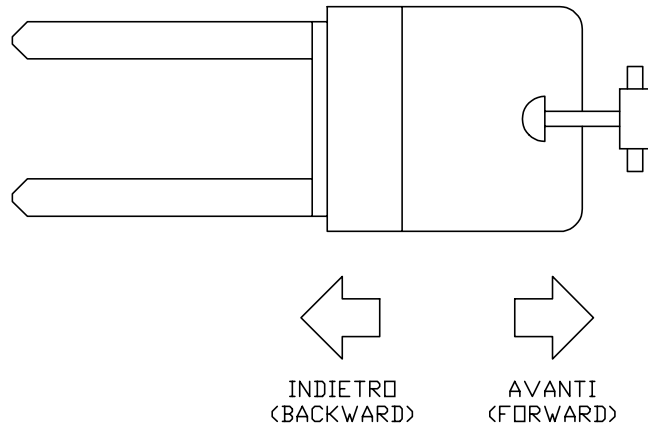

## 1.6 GENERAL NOTES AND PRECAUTIONS

- Never combine SCR based low frequency choppers with H0 boards, for filter capacitors inside H0 board modify SCR chopper functioning, and, moreover, they go under overload. In case you need to use two or more control units (pump + traction, etc.) all of them have to belong to the same High Frequency Zapi MOS family.
- Do not connect chopper to a battery whose nominal voltage is different from that outlined on H0 board. Greater battery voltages can lead to MOS breaking, while under lower ones the device does not work.
- During battery charging, the device must be disconnected from the battery itself because not only it modifies battery charge status (read through battery-meter), but even it can be damaged from over voltages generated by battery charger device and ripple current, generated within capacitors if battery charger is a low frequency one.
- Feeding H0 board exclusively with traction battery, do not use power supply's or converter's output; for special use please contact local Zapi's technical centre.
- Turn on the machine, the first time, with raised wheels to prevent dangerous conditions to occur, due to cabling errors.

## 1.7 SUSCEPTIBILITY AND ELECTROMAGNETIC EMISSION

Susceptibility and electromagnetic emission are remarkably affected by installation procedure; attention should be applied towards electric connection path, length and towards shielding.

Therefore Zapi declines any responsibility for any sort of not correct functioning due to what mentioned above, mostly if machine builder should fail in undertaking test required by current laws (irradiate emission, EN 50081-2).



## **2 INSTALLATION**

### **2.1 POSITIONING AND THERMAL DISSIPATION**

Chopper is to be installed on a flat metallic plate, unpainted and clean.

Between the 2 surfaces a light layer of thermo-conductive grease to allow a better heat conveyance is to be laid down.

Chopper has got a IP20 protection level, so it's necessary housing the chopper in such a place to be enough protected against sprinklings and drippings.

To fix the chopper make use of fitting holes on clamping plate.

Verify that head-ropes and connector cabling are correctly accomplished.

### **2.2 CHOOSING CONNECTION CABLING**

For auxiliary circuits 0.5 mm<sup>2</sup> cross-section wires shall be used.

For power connection toward motor and battery 16 mm<sup>2</sup> cross-section wires shall be used.

To improve chopper performance wires toward battery shall be aligned each other and as short as possible.

### **2.3 CONTACTORS**

Choosing contactor type depending upon maximum current rating the motor is expected to work.

- Current soaked up through coil shall not exceed 3 Amps.
- Coil suppressers are chopper inside, therefore do not use arc-suppresser-built-in contactors.
- Do protect contactor's contacts against dust, dirty, external agents which can lead to jeopardise performance and good functioning.

### **2.4 FUSES**

- To protect auxiliary circuits do use a 10 Amps fuse.
- To protect power circuits do use a 160 Amps fuse; if the fuse shall protect pump circuit its value has to be increased as much as the amount of current soaked up by pump in full load condition.

Shown value is the maximum allowed; for applications or special applications it can

## 2.5 ARC SUPPRESSER

- Solenoid valves, contactors not handled by chopper, motor-horn, any other kind of inductive loads shall be mounted in parallel.  
Provided the arc suppresser consists of a diode, this is required to carry on the same current as the coil.
- Here you can find examples:
  - a) for pump contactor or relay.

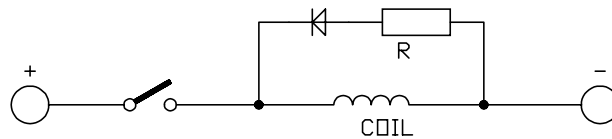

R resistor value shall be about the same of coil resistance value; power level is to be computed as follows:

$$P_w = \frac{V^2}{10R}$$

EXAMPLE: compute proper value for arc-suppresser of a contactor featuring 18 $\Omega$  coil resistance, 24 V .

$$R_\Omega = 18\Omega$$

$$P_w = \frac{24^2}{10 \cdot 18} = \frac{576}{10 \cdot 18} = 3.2 \text{ W}$$

therefore you will use a 18 $\Omega$ /3W resistor.

b) Motor-horn:

Combine a 10MF/100V capacitor in parallel to motor-horn contacts.

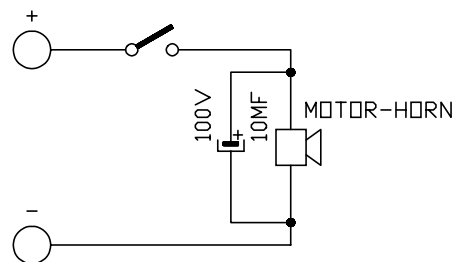

## 2.6 DIMENSIONS

## **2.7 MECHANICAL DRAWING WITH CONTACTORS**

## 3 CONNECTORS

### 3.1 CONNECTORS POSITIONS

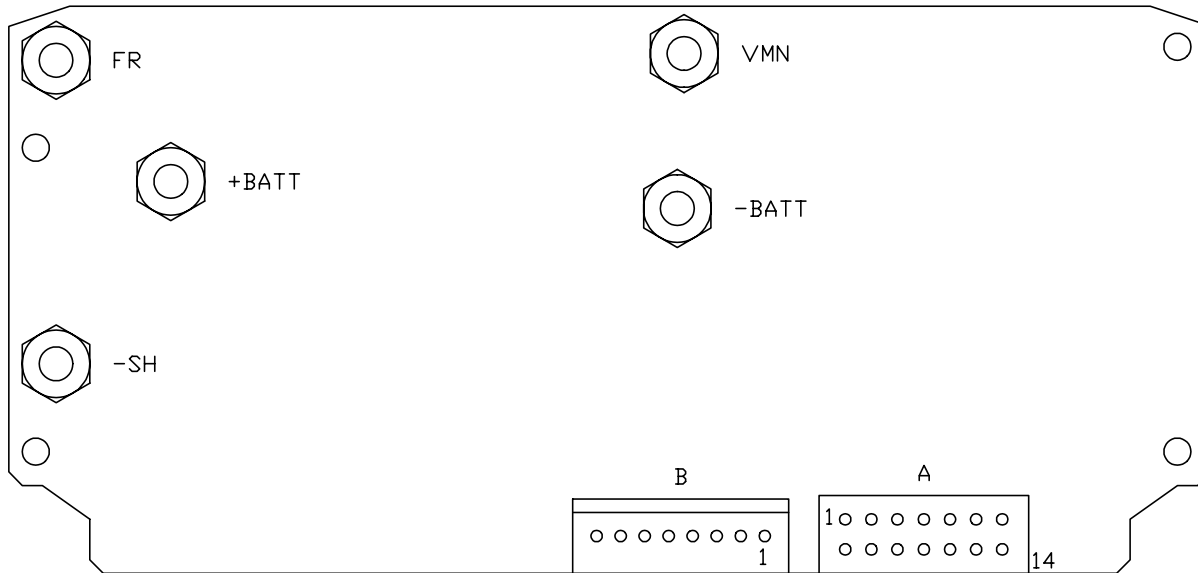

### 3.2 CONNECTORS DESCRIPTION

position	function	description
A1	RV1	Speed reduction no 1 input; normally close contact toward battery positive: active when pin is free.
A2	IRE	Europe quick inversion input; normally open contact; active when pin is connected to battery positive.
A3	MT	Tiller or seat microswitches; normally open contact; running is permissible when the pin is connected to battery positive.
A4	NT2	Output for control toward forward contactor coil negative on autostop configuration. Or output for electro-brake, by-pass, main contactor on standard configuration.
A5	CH	Key contact input for chopper feeding

A10	MI	Backward running request input; normally open contact: request is active when contact is closed to battery positive.
A11	NT1	Output for command to backward contactor coil negative on autostop configuration; or running contactors common return on standard configuration.
A12	NPOT	Potentiometer negative: it provides a negative to potentiometer for speed control; between this pin and negative a diode is put in order to sense potentiometer presence or its correct placing.
A13	CPOT	Potentiometer central: speed control potentiometer signal is applied in; range varies either from 0.6V to 10V or from 0.6 to 3.4V if TYPE PEDAL=OFF is programmed.
A14	PPOT	Potentiometer positive: output where positive supply for potentiometer is drawn; output potential is 13V while output impedance is 82ohm.

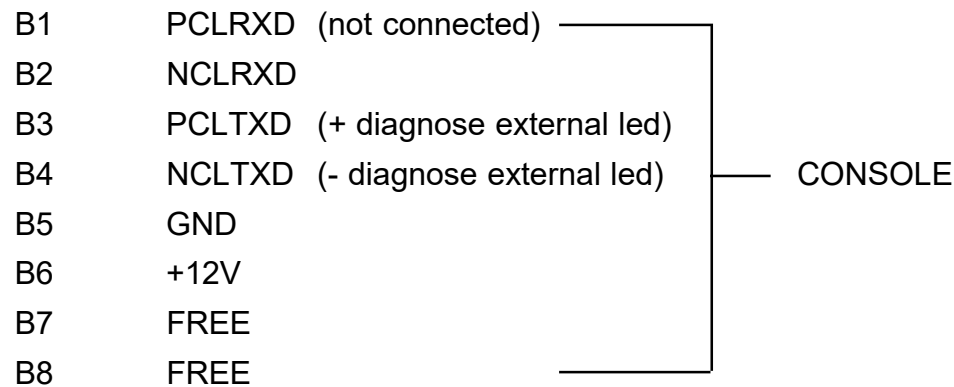

### 3.3 POWER CONNECTOR DESCRIPTION

+BATT	= Battery positive.
-SH	= Motor positive beyond current sensor
FR	= Braking diode anode
VMN	= Output for motor control.
-BATT	= Battery negative.

## 4 PROGRAMMING BY CONSOLE

### 4.1 SETTING BY CONSOLE

Parameters and configuration setting are accomplished through programming console.  
It has to be connected to fitting connector B.  
Execute connection while the machine is off.

 **Pay attention to console connector polarity when inserting on chopper.**

### 4.2 PROGRAMMING CONSOLE

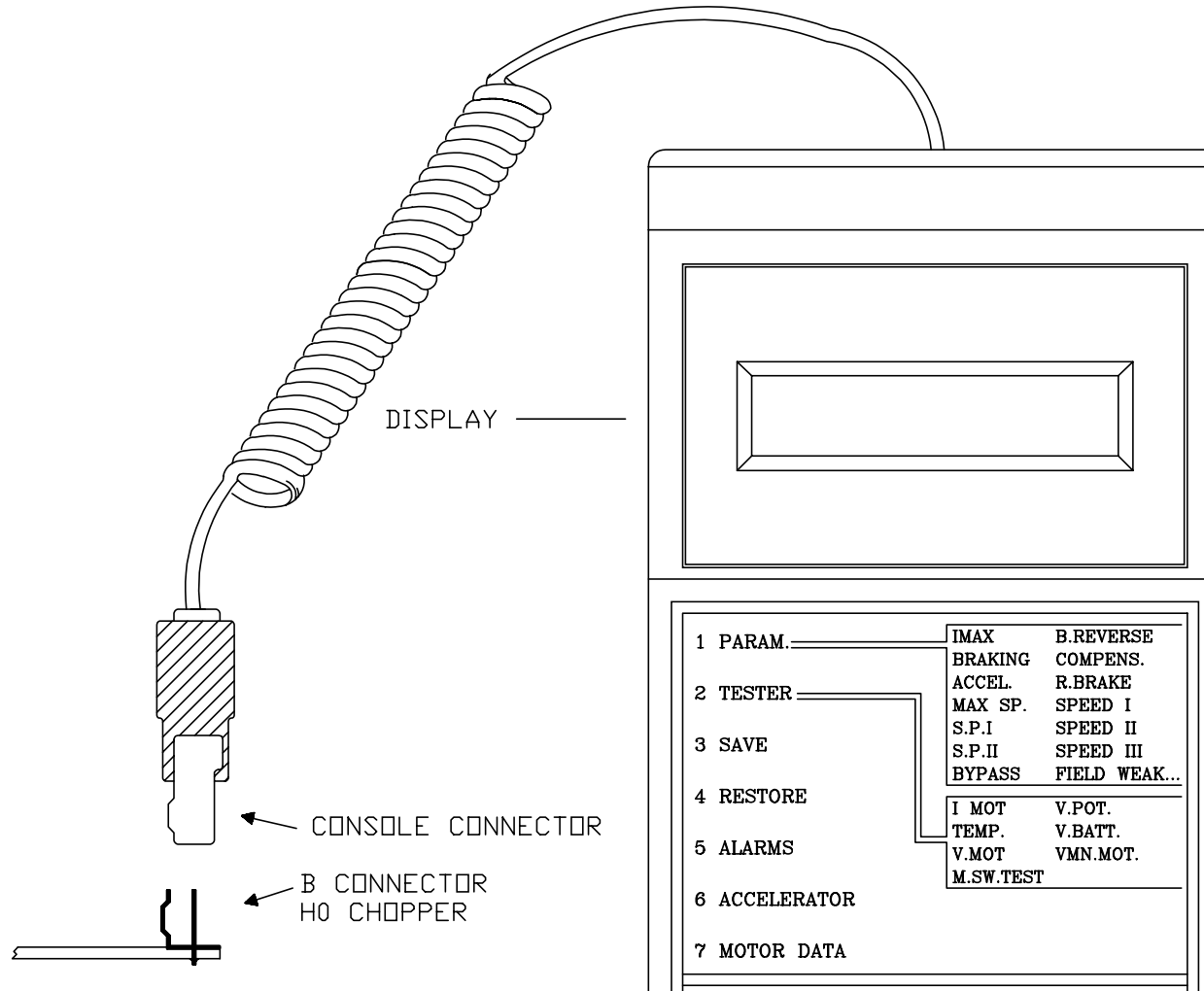

### 4.3 CONSOLE FUNCTIONS CHART

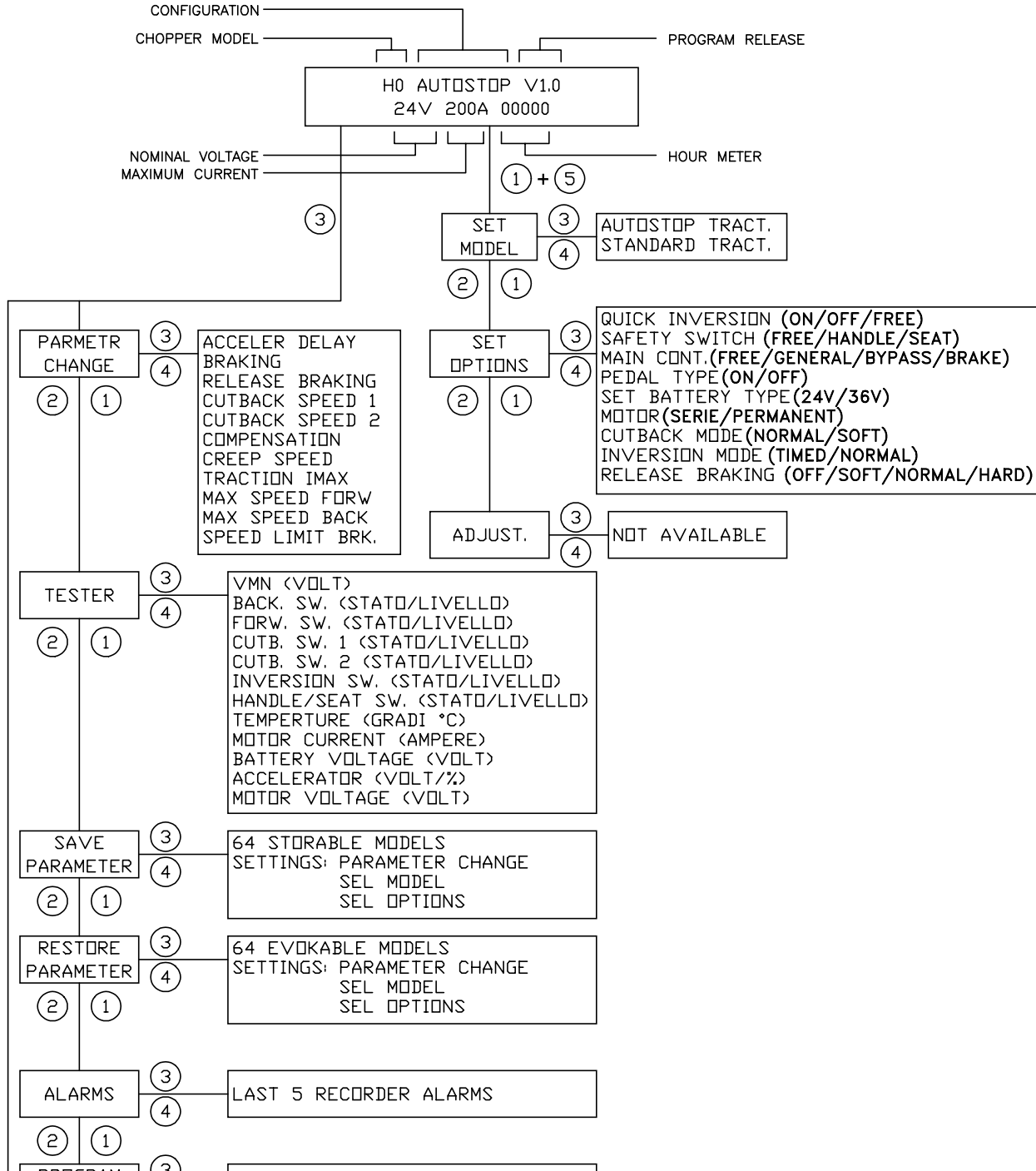



## 4.4 MODEL: CONFIGURATION MODE

By SET MODEL menu H0 chopper can be set into 2 different models:

- 1) AUTOSTOP TRACT. Automatic braking is provided while releasing running request microswitches; both NT1 and NT2 driver's outputs are used to handle running contactors.
  
- 2) STANDARD TRACT. NT1 driver is used to handle, in common, running contactors negative; since positive is given to contactors by running microswitches release braking is not provided. Second driver (NT2) is used for one of following 3 option:
  1. electrobrake;
  2. by-pass;
  3. main contactor.
 they're programmable by console through SET OPTIONS menu.

How to do programming set up using console.

- 1) Head-line
- 2) Push ROLL UP + SET-UP simultaneously
- 3) SET MODEL menu head-line appears
- 4) Push ENTER
- 5) Current configuration model appears
- 6) Use SET UP o SET DOWN key to change model selection
- 7) Selected new model appears
- 8) Push OUT to exit selecting mode
- 9) Modifies confirm request appears

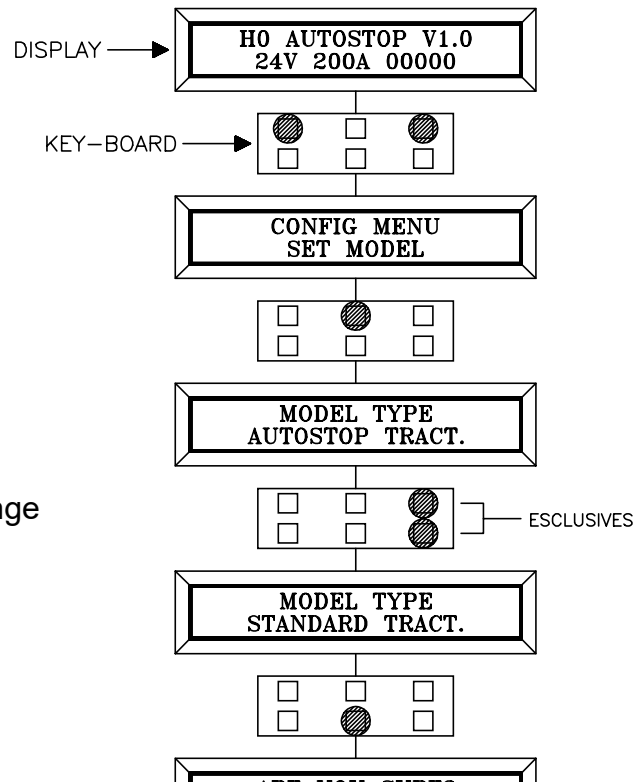

## 4.5 OPTION: CONFIGURATION MODE

Option configuration (SET OPTIONS menu) allows you to select functioning mode for part of inputs and outputs, as described below:

QUICK INVERSION: (IRZ-A6, IRE-A2)	ON =	IRE (A2) input, active high, is used for safety management when quick inverting; it's to be programmed in this way for all applications where type Europe quick inversion is implemented.
	OFF =	IRZ (A6) input, active low, is used for safety management when quick inverting; it's to be programmed in this way for all applications where type Zapi quick inversion is implemented.
	FREE =	IRE and IRZ inputs are not use; it's to be programmed in this way for all applications where safety button for quick inversion is not used (machine with sitting man on board). Keep A2 and A6 pins free.
SAFETY SWITCH: (MT-A3)	FREE =	MT (A3) input is used for accepting running without any operation sequence, i. e. it's enough having this input together with running request.
	HANDLE =	MT (A3) input is used for accepting running from tiller. A correct sequence is requested: first tiller then running.
	SEAT =	MT (A3) input is used for accepting running from seat microswitch. A correct sequence is requested, first seat then running; deactivation is delayed of 2 seconds after micro-seat opening.
MAIN CONT.: (NT2-A4)	FREE =	The output is unused. Internal contact is always open.

PEDAL TYPE: (CPOT-A13)	ON =	CPOT input (potentiometer central) works within the range 0.6V to 10V.
	OFF =	CPOT input (potentiometer central) works within the range 0.6V to 3.4V.
SET BATTERY TYPE:	24V =	Choose this option FOR 24V model chopper.
	36V =	Choose this option FOR 36V model chopper.
MOTOR :	SERIE =	Chopper is arranged to work together with a series excited motor.
	PERMANENT=	Chopper is arranged to work together with a permanent magnet motor.
CUTBACK MODE: (RV1-A7, RV2-A1)	NORMAL =	When both speed reductions are simultaneously activated the lower one prevails.
	SOFT =	When both speed reductions are simultaneously activated a speed of about 70% of lower one is accomplished.
INVERSION MODE	NORMAL =	When quick inversion safety function is activated, the machine, after braking interval, proceeds backwards at 50% speed, for whole time button is being pressed.
	TIMED =	When quick inversion safety function is activated, the machine, after braking interval, proceeds backwards at 50% speed, for no more than 2 second time; afterwards the machines stops though button is still being pressed.
RELEASE BRAKING:	OFF =	Search for the turn-on of the braking with a ramp about 5% of duty cycle.
	SOFT =	Search for the turn-on of the braking with a ramp about 10% of duty cycle.

How to do programming set-up using console.

1) Head-line

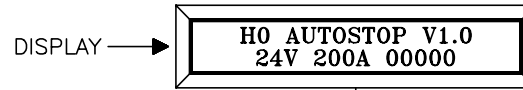

2) Push ROLL UP + SET UP to enter SET menu

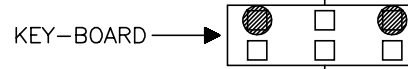

3) SET MODEL menu head-line appears

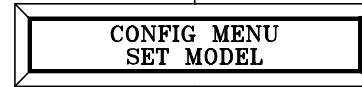

4) Press ROLL UP to select SET OPTIONS menu

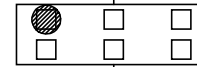

5) SET OPTIONS menu head-line appears

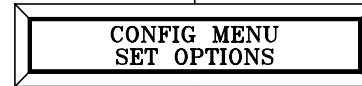

6) Push ENTER to enter menu

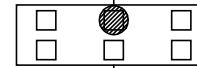

7) Menu first item appears

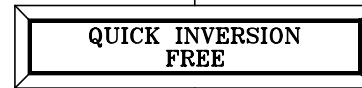

8) A new item appears

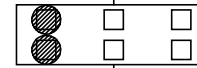

9) Menu new item appear



10) Press SET UP or SET DOWN to change configuration

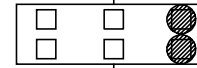

11) The new configuration appears

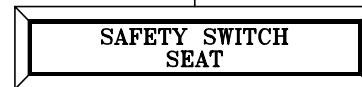

12) Press OUT to exit menu

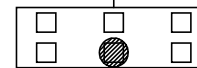

13) Modify confirm request appears

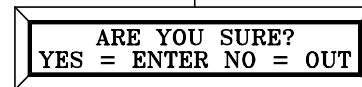

14) Press ENTER to confirm change, or press OUT to cancel changes

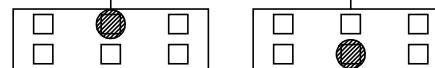

15) SET OPTIONS menu head-line appears



16) Press OUT to return to head-line

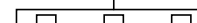

## 4.6 PARAMETERS: CONFIGURATION MODE

Chopper adjustment parameters level regulation is accomplished by PARAMETERS CHANGE menu. For each parameter 10 adjustment intensity levels are available. Following you'll find reported parameters meanings and regulation range.

- ACCELER.DELAY:** Acceleration time, i.e. minimum time during which motor voltage ranges from minimum to maximum.
- BRAKING:** Braking base current on running direction inversion: a value, depending upon accelerator, shall be added to it.
- RELEASE BRAKING:** Running request releasing braking current (only autostop). If level 0 programmed the machine doesn't execute the release braking.
- CUTBACK SPEED 1:** Speed reduction n.1 associated to A1 input.
- CUTBACK SPEED 2:** Speed reduction n.2 associated to A7 input.
- COMPENSATION:** Speed compensation (motor voltage), current function when speed reductions are active; compensation is activated only while pedal is being pressed over 80% available stroke.
- CREEP SPEED:** It sets motor applied voltage minimum value with running request on. It allows a quick response at starting.
- TRACTION IMAX:** It sets maximum chopper current both during running and during braking sequences.
- MAX SPEED BACK:** Maximum speed when backward running is selected; may be managed by compensation.
- MAX SPEED FORW:** Maximum speed when forward running is selected; may be managed by compensation.
- SPEED LIMIT BRK:** It defines speed over which AUTOSTOP braking is activated at running releasing.

### 4.6.1 Settings

PARAMETERS	UNIT	PROGRAMMED LEVEL									
		0	1	2	3	4	5	6	7	8	9
ACCELERATION DELAY	Sec.	0.4	0.8	1.2	1.6	2.0	2.3	2.7	3.1	3.5	3.8
BRAKING	% IMax.	50	55	60	65	70	75	80	85	90	95

How to do programming set up using console.

1) Head-line

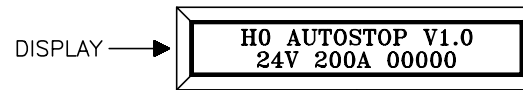

2) Press ENTER to enter main menu

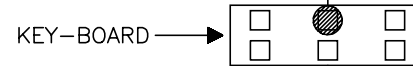

3) PARAMETER CHANGE, first item head-line, is shown

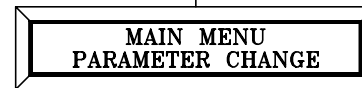

4) Press ENTER to enter PARAMETER function

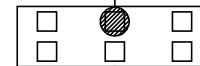

5) First parameter on list is shown

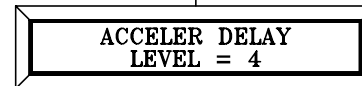

6) by ROLL UP and ROLL DOWN examine parameter list



7) Parameters items are shown

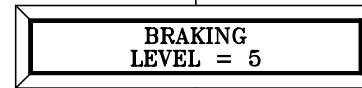

8) By SET UP and SET DOWN change programming level

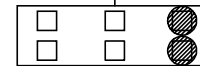

9) New selected value is shown

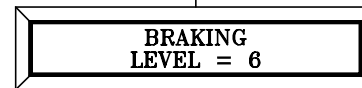

10) Press OUT when programming is over

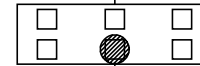

11) Change confirm request is shown

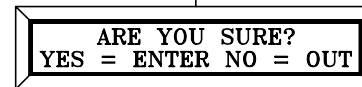

12) Press ENTER to confirm change, or press OUT to cancel it

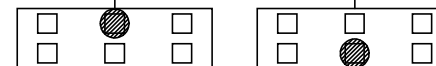

13) PARAMETER CHANGE head-line is shown



14) Press ROLL UP or ROLL DOWN to view other items, or press OUT to come back to beginning head-line

## 4.7 CONSOLE TESTER MENU: DESCRIPTION

Some of more important input/output signals can be tested in real time using console tester function. Below you find a list of tested signals and their meanings:

VMN: Voltage mean value measured between Battery negative and VMN clamp.

Capacity=42.5V, resolution=0.2V, accuracy = ±3%.

BACK SW: it's backward running digital input status (MI pin A10)

ON/+VB= (  ) active input, voltage on connector

OFF/GND = (  ) not active input, free connector.

FORW SW: it's forward running digital input status (MA pin A9)

ON/+VB= (  ) active input, voltage on connector

OFF/GND = (  ) not active input, free connector.

CUTB.SW 1: it's speed reduction n.1 digital input status (RV1 pin A1)

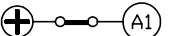
OFF/+VB= (  ) non active input, voltage on connector

ON/GND = (  ) active input, free connector.

CUTB.SW 2: it's speed reduction n.2 digital input status (RV2 pin A7)

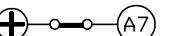
OFF/+VB= (  ) non active input, voltage on connector

ON/GND = (  ) active input, free connector.

INVERSION SW: Quick inversion digital input status (IRE pin A2 or IRZ pin A6).

If QUICK INVERSION option is programmed ON (IRE pin A2):

ON/+VB= (  ) active input, voltage on connector

OFF/GND = (  ) not active input, free connector.

If QUICK INVERSION option is programmed OFF (IRZ pin A6):

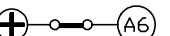
OFF/+VB= (  ) not active input, voltage on connector

ON/GND = (  ) active input, free connector.

HANDLE /SEAT SW: Tiller approval digital input status (MT pin A3)

ON/+VB= (  ) active input, voltage on connector

OFF/GND = (  ) not active input, free connector

**ACCELERATOR:** It's voltage related to accelerator signal (CPOT pin A13) read by microprocessor below ampli. circuit.  
 range = 0V ÷ 5V, resolution 20mV, accuracy = ±5%  
 Warning: read voltage through this function is not the one taken on A13 (CPOT) connector, but the one specifically read by microprocessor.

**MOTOR VOLTAGE:** It's motor applied voltage, measured between -SH and WMN clamps:  
 VMN range = 0V ÷ 42.5V, resolution 0.2V, accuracy = ±3%

How to enter console TESTER function :

1) Head-line

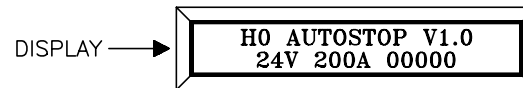

2) Press ENTER to enter main menu

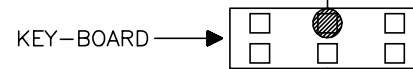

3) First item on list is shown

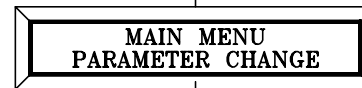

4) by ROLL UP and ROLL DOWN keys examine list.  
 Select TESTER

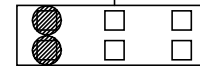

5) Item selected (TESTER) is shown

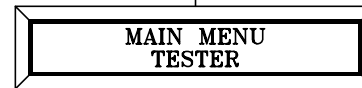

6) Press ENTER to get into TESTER function

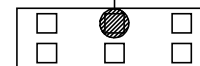

7) First tested signal is shown

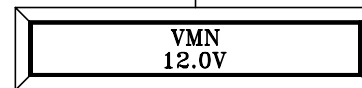

8) By ROLL UP and ROLL DOWN keys view tested signals

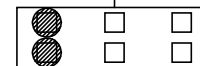

9) Following signals are shown

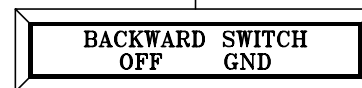

10) Press OUT to come back to list

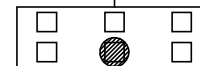

11) Selected item is shown

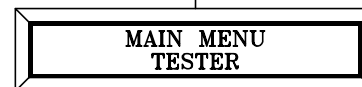



## 4.8 SAVE PARAMETER MENU: DESCRIPTION

SAVE PARAMETER function allows loading, on console memory, parameters values and chopper configuration data. It's possible to load up to 64 different programs. Data, saved on console memory, can later be re-loaded on another chopper by means of RESTORE function (par.4.9).

Data loaded through SAVE function are:

- All range of parameter' s values (PARAMETER CHANGE)
- Options settings (SET. OPTIONS)
- Model setting (SET.MODEL)

How to execute SAVE operation by console:

- 1) Head-line
- 2) Press ENTER to enter main menu
- 3) First item on list is shown
- 4) by ROLL UP and ROLL DOWN keys examine list.  
Select SAVE PARAMETER.
- 5) Item selected (SAVE PARAMETER.) is shown
- 6) Press ENTER to get into SAVE function
- 7) On upper line, model selected code is shown;  
on lower line, FREE is displayed if module box  
is free, or model name if engaged.
- 8) By ROLL UP and ROLL DOWN keys select model code.
- 9) New selected code and related  
conditions (FREE/OCCUPATO) are displayed
- 10) Press ENTER to confirm reading procedure
- 11) On second line already stored parameters items

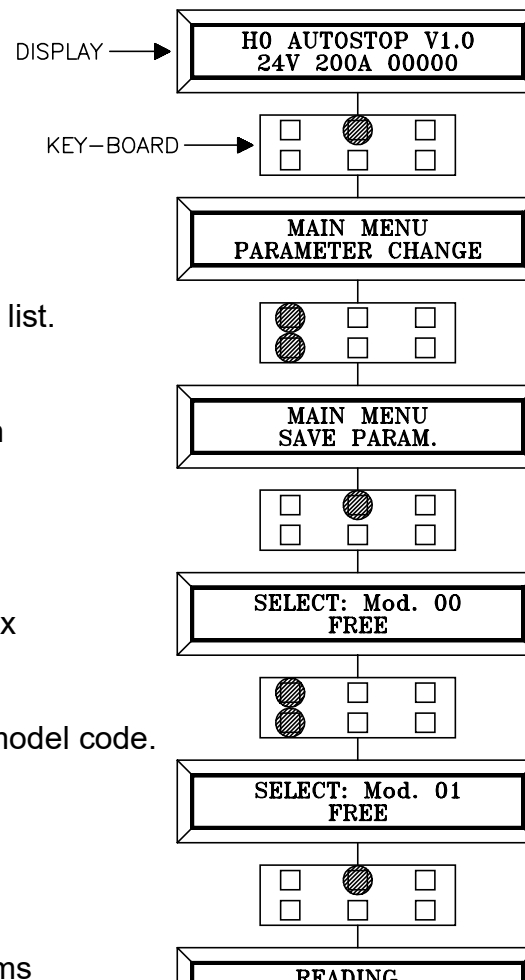

## 4.9 RESTORE PARAMETER MENU: DESCRIPTION

RESTORE PARAM. function allows transfer data, stored inside console memory, into chopper memory thus accomplishing chopper adjusting in the same way as the model loaded through SAVE PARAM. operation.

Data loaded into chopper through RESTORE PARAM.function are:

- All range of parameter' values (PARAMETER CHANGE)
- Options settings (SET. OPTIONS)
- Model setting (SET.MODEL)

**Warning:** RESTORE execution overwrite all chopper data, therefore, after such an operation, all old data inside chopper are erased.

How to execute RESTORE operation by console:

- 1) Head-line
- 2) Press ENTER to enter main menu
- 3) First item on list is shown
- 4) by ROLL UP and ROLL DOWN keys examine list.  
Select RESTORE PARAM.
- 5) Item selected (RESTORE PARAM.) is shown
- 6) Press ENTER to get into RESTORE PARAM. function
- 7) On upper line model selected code is shown;  
on lower line chopper type stored into memory is displayed.
- 8) By ROLL UP and ROLL DOWN keys select desired model code.
9. New selected model code and related stored chopper type is shown.
10. Press ENTER to confirm loading procedure

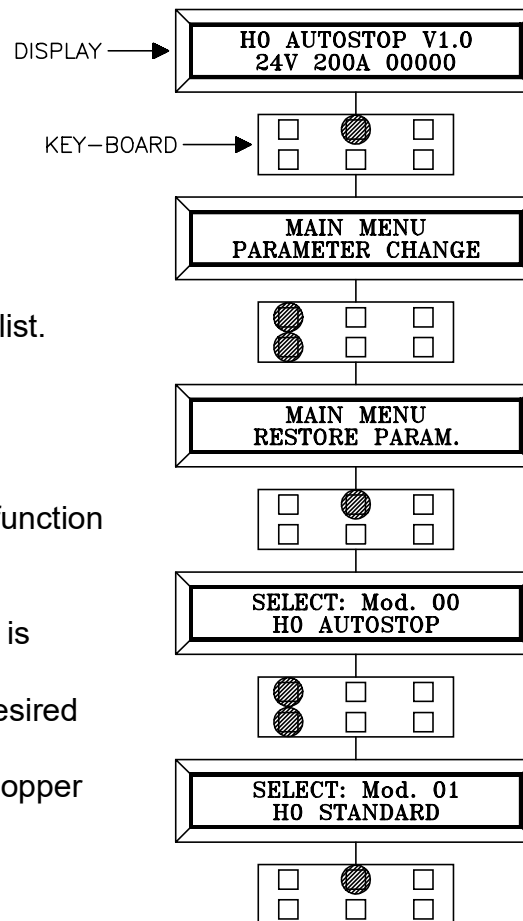

## 4.10 ALARMS MENU: DESCRIPTION

Chopper can store the last 5 alarms found out, record their alarm code, how many times the alarm occurred, correspondent hourmeter and temperature values. You can get into this data base through console ALARMS menu.

This function allows you to execute a deeper and more accurate diagnosis, giving you possibility of viewing occurred alarm historical background.

How to get into ALARMS menu

1) Head-line

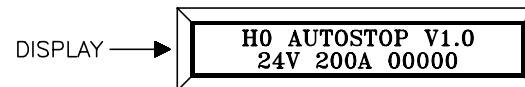

2) Press ENTER to enter main menu

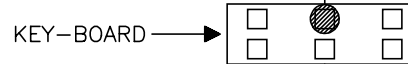

3) First item on list is shown

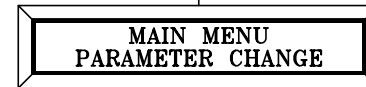

4) by ROLL UP and ROLL DOWN keys examine list.  
Select ALARMS.



5) Item selected (ALARMS) is shown

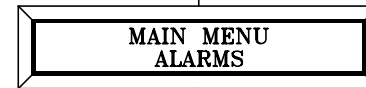

6) Press ENTER to get into ALARMS function

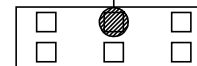

7) Last recorded alarm is shown together with following ones, hourmeter value, temperature.

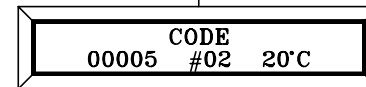

8) By ROLL UP key check previous alarms, while by ROLL DOWN key return to recent ones.



9) A new alarm code is shown. If no alarms occurred ALARM NULL is shown

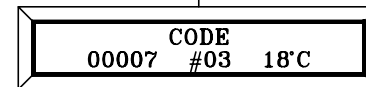

10) Press OUT to exit ALARMS menu.

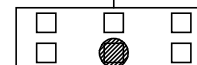

11) Request for erasing stored alarms is shown.

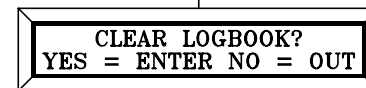

12) Press ENTER to erase.

Press OUT to come back to main menu.

## 4.11 PROGRAM VACC FUNCTION : DESCRIPTION

Through this function you can take in minimum and maximum accelerator signal value for both running directions. This function becomes essential to compensate incidental dissimetries on mechanic elements aimed to control potentiometer. Operation is executed moving directly pedal or butterfly, after entering PROGRAM VACC menu, accomplishing operations described as follows:

How to get into PROGRAM VACC menu and execute operations:

- 1) Head-line
- 2) Press ENTER to enter main menu
- 3) First item on list is shown
- 4) by ROLL UP and ROLL DOWN keys examine list. Select PROGRAM VACC.
- 5) Item selected (PROGRAM VACC) is shown
- 6) Press ENTER to get into PROGRAM VACC function
- 7) Current maximum values related to forward and backward running direction are displayed.
- 8) Press ENTER.
- 9) Now chopper is ready to record potentiometer minimum and maximum signal.
- 10) Press the pedal (or roll the butterfly on both direction), paying attention in moving slowly, at the beginning of the stroke, and while arriving at complete end-stroke. NOTE: select one direction, if you use pedal.
- 11) New maximum and minimum value, for both running direction, are displayed.

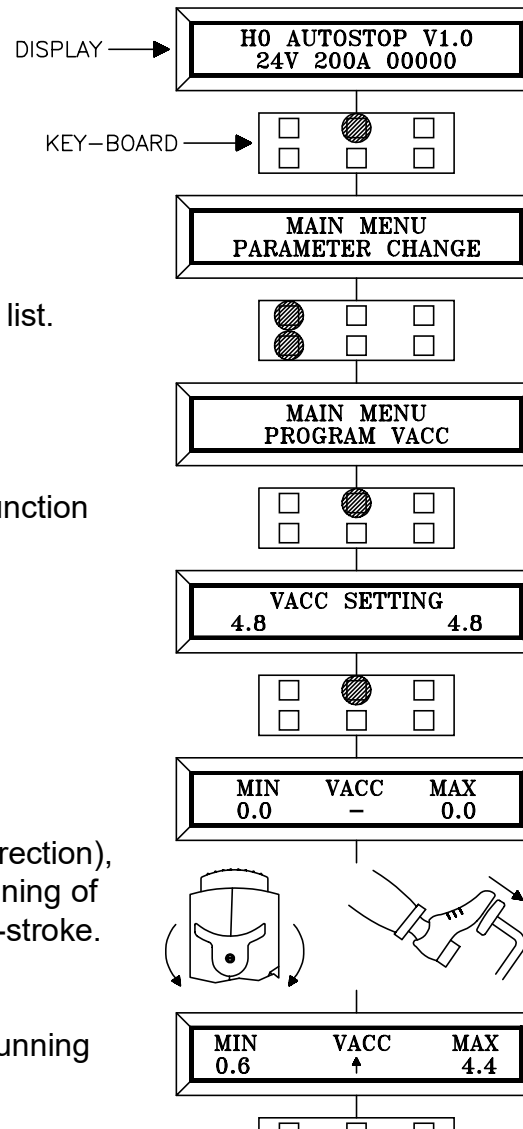

## 4.12 MOTOR DATA FUNCTION : DESCRIPTION

This function is used to store motor resistance value, in rotor blocked condition, to manage braking properly. This operation is to be accomplished when chopper is installed on machine.

How to get into MOTOR DATA menu and execute operations:

1) Head-line

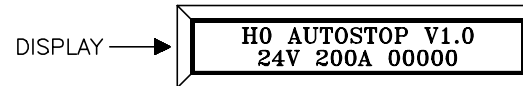

2) Press ENTER to enter main menu



3) First item on list is shown

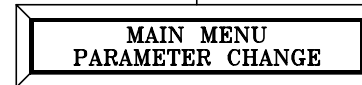

4) by ROLL UP and ROLL DOWN keys examine list.

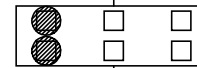

5) Select MOTOR DATA.

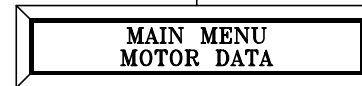

6) Press ENTER to get into MOTOR DATA function

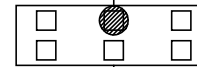

7) Current data value is displayed.

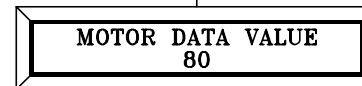

8) Press ENTER to arrange acquisition procedure.

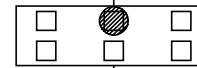

9) A message on operation to be executed is displayed.

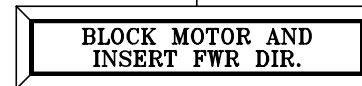

10) Stop rotor pressing brake pedal or disconnecting electrobrake and keeping machine facing a wall. Whether programmed as H0 STANDARD, with electrobrake handled by chopper, this one is automatically being braked during MOTOR DATA operation.

11) Take tiller (or consensus) in running position

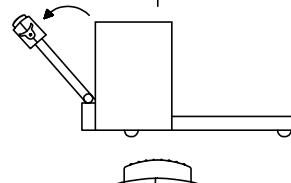

### 4.13 ADJUSTMENT PROCEDURE

While the truck is off, connect programming console, switch on, head-line appears on display.

If the chopper has already been configured into the model requested (autostop or standard) go to point 3; otherwise proceed as follows:

- 1) Configure chopper model: choose a model fitting to the function requested and the cabling used. (see par. 4.4).
- 2) Configure options (see par. 4.5).
- 3) Verify perfect functionality of all cabled inputs, including potentiometer, using console TESTER function (see par. 4.7).
- 4) Execute acquisition of accelerator signal with PROGRAM VACC menu (see par. 4.11)
- 5) Select maximum current value, programming it at a desired value level, as reported on H0 regulating schedule (see par. 4.6.1).
- 6) Execute MOTOR DATA, as described at par. 4.12.
- 7) Adjust CREEP value, starting from 0 level; while machine is off press lightly pedal in order to trigger running microswitch, leaving potentiometer at minimum value, then arise CREEP level until the machine starts moving.
- 8) Adjust acceleration (ACCELERATION DELAY) making some standing-starts in both directions.
- 9) Release braking (RELEASE BRAKING) should be adjusted launching machine, then releasing entirely pedal or butterfly and selecting desired intensity.  
To have a better working you must employ the right trip level of braking turn-on ramp. To do that you shall work on the parameter RELEASE BRAKING into the menu options choosing which one of the four levels (OFF / SOFT / NORMAL / HARD) is the most opportune. Too much low trip level could not let the turn-on braking, while too much high trip level cause a harsh turn-on.
- 10) Inversion braking (BRAKING) is tested launching machine, then inverting running direction request: choose desired braking intensity.
- 11) Speed reduction (CUTBACK SP1 and CUTBACK SP2) shall be adjusted first with unloaded truck on flat ground, setting COMPENSATION parameter at 0 level; once defined the desired speed put on load and adjust COMPENSATION (feedback) parameter until you achieve desired speed.
- 12) Forward/backward maximum speed (MAX SPEED FORW and MAX SPEED BACK)

## 5 DIAGNOSIS

### 5.1 COMPONENT SELF DIAGNOSIS

Microprocessor carries out diagnosis over main chopper functions, involving 4 basic points:

- 1) diagnosis on key start-up which includes: WatchDog test, current sensor test, power mosfet test, contactor drivers test, test for running request present, accelerator test, EEPROM test.
- 2) Stand-by diagnosis which includes: WatchDog test, power mosfet test, current test, contactor drivers test, accelerator test.
- 3) Diagnosis while running which includes: WatchDog test, power mosfet test, current test, contactor drivers test, accelerator test, contactor opening-closing test.
- 4) Parameter diagnosis: temperature check, battery charge test.

The diagnostic message on possible fault, is indicated by a certain number of blinks of the LED connected to connector A (see par. 5.2).

The current alarm message code can be displayed on the programming console (see par. 5.3).

## 5.2 DIAGNOSIS LED RECEIVED ALARMS: DECODING

NUMBER OF BLINKS	MESSAGE	STATE*	NOTES
1	WATCH-DOG	A	Fault on logic board
1	EEPROM	A	Fault on E <sup>2</sup> prom logic board
1	EEPROM	A	Fault on E <sup>2</sup> prom logic board
1	EEPROM	A	Fault on E <sup>2</sup> prom logic board
1	EEPROM	A	Fault on E <sup>2</sup> prom logic board
2	INCORRECT START	B	Running request (fault while connecting IR)
3	VMN LOW	B	Short circuite mosfet
3	NO FULL COND.	A	Full condution isn't checked
3	VMN HIGH	B	Short circuite diodes or stuck contactor
4	VACC NOT OK	B	Unsettled potentiometer
5	I=0 EVER	A	Failure of current signal on running
5	HIGH CURRENT	A	High current in stand-by
6	PEDAL WIRE KO	B	Potentiometer supply wire disconnected
7	TEMPERATURE	C	T° > 76°C
8	DRIVER 1 KO	A	Short circuited NT1 driver
8	DRIVER 1 SIC KO	A	Short circuited backward contactor coil
8	DRIVER 2 KO	A	Short circuite NT2 driver
8	DRIVER 2 SIC KO	A	Short circuited forward contactor coil
8	DRIVER SHORTED	B	Short circuited NT1 driver
8	CONTACTOR OPEN	B	Contactor doesn't close
9	POSITION HANDLE	B	Error on tiller position at starting
9	INVERSION	B	Error in cabling or IR key pressed at starting
FIXED	FORW+BACKW.	B	Double running request
CONTINUOUS	BATTERY	C	Discharged battery, beyond safety level

\*

A = remove fault and reset key to start again.

B = remove fault and reset running to start again.

C = It's an indication and involve only software measures.

A more detailed description on alarms messages is carried out on paragraph 5.3.



### 5.3 CONSOLE DISPLAYED ALARMS: DECODING

In this paragraph console alarm message meanings, both those displayed during an alarm in progress and those stored into memory within ALARM menu are reported.

#### 1) **WATCHDOG**

The test is made in both running and standby. It is a self-diagnosis test within the logic, and executes a cross software and hardware verify. If this alarm should occur, replace the logic.

#### 2) **EEPROM PAR.KO**

Fault in the area of memory in which the adjustment parameters are stored. This alarm inhibits machine operation. If the defect persists when the key is switched off and on again, replace the logic. If the alarm disappears, remember that the parameters stored previously have been cancelled and replaced by the default values.

#### 3) **EEPROM CONF.KO**

Fault in the area of memory in which the special chopper configuration data is stored. If the defect persists when the key is switched off and on again, replace the logic. Otherwise, keep in mind that the chopper configuration has been reset to the default values; thus it must be reprogrammed. consult the console manual.par 4.4, 4.5, 4.6.

#### 4) **EEPROM DATA KO**

The data in the area of memory for the hour-metre is incorrect. This alarm does not shut down the machine. If the alarm disappears when the key is switched off and on again, keep in mind that the hour-metre data has been reset to zero.

#### 5) **EEPROM OFF LINE**

Fault in the nonvolatile memory that contains data relative to the area for the hour-metre, the alarms stored and the programming parameters.

If the alarm persists when the key is switched off and on again, replace the logic.

#### 6) **INCORRECT START**

An incorrect starting sequence. The machine only starts if this sequence is followed:

1 key / 2 handle / 3 running (if safety switch = handle)

1 key / 2 running (if safety switch = free)

1 key + seat / 2 running (if safety switch = seat)

Possible causes:

a) Running microswitch stuck.

b) Error in sequence executed by the operator, id est running request previous to key start-up or before pulling down tiller

## 7) VMN LOW

It shows that voltage on VMN bar is low (<30% VD); usually this voltage should rate 1/2 battery voltage, when contactors are open. The test is carried out at standby and in running up to 80% of PWM.

Possible causes:

- a) If main contactor is installed either it does not close and it's likely not connected or resistor, presumably placed in parallel to contacts, is blown up.
- b) Check if there are metallic particles thus causing short circuit between VMN cabling and battery negative cabling (-B).
- c) Power mosfet shorted or continuously piloted by logic: to verify that disconnect the cable away from VMN bar, then start the device; if the fault is lasting replace the chopper.
- d) If by-pass contactor is installed, verify either it's not stuck or excessively slow when opening.

## 8) VMN HIGH

It indicates that voltage on VMN bar is high (> 70% VB); usually this voltage should be 1/2 battery voltage.

Possible causes:

- a) Running contactor is ever closed for either it's stuck or it is ever supplied due to a wrong wiring toward coil.
- b) Either a current dispersion or a short circuit between stator and rotor winding is found out: to verify it disconnect VMN bar cable and the alarm should disappear. Motor is to be repaired.
- c) Motor cabling connection error: check carefully that rotor and stator are exactly cabled as shown on schemes.
- d) Defects on chopper power board due to either flywhell or braking diode, which may be shorted. To verify that defect is on chopper, disconnect VMN bar cable, then if alarm remains replace chopper.

## 9) VACC NOT OK

The test is made in standby. The alarm indicates that the accelerator voltage is greater than 1V with respect to the minimum value stored with PROGRAM VACC function. Most likely reason is that either potentiometer or inductive sensor (in pedal or tiller) become unsettled.

## 10) I=0 EVER

Test carried out in running. Checks that the current during running is greater than a minimum value. If not, an alarm is signalled.

## 12) PEDAL WIRE KO

On NPOT pin (A12), where potentiometer negative is connected, no voltage is detected, thus indicating that potentiometer is not supplied due 1 of 2 supply wires cut off.

Possible causes:

- a) wire toward PPOT (A14) is disconnected
- b) wire toward NPOT (A12) is disconnected
- c) Potentiometer resistance is cut off.
- d) Potentiometer presents a resistance greater than 47Kohm

## 13) TEMPERATURE

It's an indication that the chopper temperature has exceeded 76°C.

The maximum current is gradually reduced, reaching 0 at a temperature of 86°C.

- a) If the alarm occurs at key start-up, while chopper is cold, most likely cause is a break down on power or logic board thermal detection circuit: replace chopper.
- b) If the alarms occurs many times soon after begin working, it's likely due to insufficient heat dissipation: check fixing nuts and correct installation.

## 14) NO FULL COND.

The test is carried out in full conduction. If, in this condition, the VMN is found to be greater than 1/3 VBATT, the diagnostic circuit is faulty, causing a safety risk, and thus machine operation is inhibited. If the defect persists, replace the logic.

## 15) DRIVER 1 KO

Indicates that NT1 (A11) connector voltage is not consistent with the expected value; the machine is inhibited.

Possible causes:

- a) either wire toward NT1 connector is disconnected or backward contactor coil is break off.
- b) Inside chopper mosfet is shorted; replace chopper.

## 16) DRIVER 1 SIC KO

It indicates a current overload on driver of contactor connected to NT1 (A11); the machine is inhibited.

Possible causes:

- a) Short circuit between positive and the wire toward NT1.
- b) Contactor coil shorted or coil current uptake greater than 5A.

## 17) DRIVER 2 KO

## 20) CONTACTOR OPEN

It attests that either one or both contactors do not close while running is requested; test is carried out checking VMN signal.

To discovery fault follow diagnosis procedure reported below.

CONDITION UNDER WHICH FAULT IS DETECTED	TEST	RESULT	TEST	RESULT	FAULT DESCRIPTION AT POINT:
ONLY AT FORWARD RUNNING REQUEST	YOU SEE FORWARD CONTACTOR (TA) CLOSING FOR 0.3sec. THEN OPENING?	YES	→	→	A1
		NO	WHEN REQUESTING FORWARD RUNNING YOU FIND ANY VOLTAGE AT COIL CONTACTS FOR 0.3 sec.?	YES	B1
				NO	C1
ONLY AT BACKWARD RUNNING REQUEST	YOU SEE BACKWARD CONTACTOR (TI) CLOSING FOR 0.3sec. THEN OPENING?	YES	→	→	A2
		NO	WHEN REQUESTING BACKWARD RUNNING YOU FIND ANY VOLTAGE AT COIL CONTACTS FOR 0.3sec.?	YES	B2
				NO	C2
AT BOTH RUNNING REQUEST	YOU SEE FORWARD OR BACKWARD CONTACTOR (TA OR TI) CLOSING FOR 0.3sec. THEN OPENING	YES	→	→	A3
		NO	WHEN REQUESTING FORWARD RUNNING YOU FIND ANY VOLTAGE AT TA COIL'S CONTACTS (OR AT BACKWARD CONTACTOR COIL'S CONTACTS (BTI)) FOR 0.3sec.?	YES	B3
				NO	C3

**A1)** There is not a good contact either on TA (=forward contactor) NA (normally open) or on TI (=backward contactor) NC (normally closed), due to dust, dirt or any particles which prevent a valid contact.

Clean contacts by means of compressed air; if necessary remove dirt applying a soft abrasive movement.

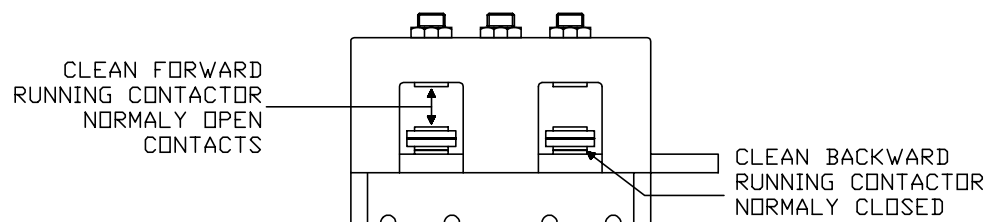

- A2)** There is not a good contact either on TI NA or on TA NC, due to dust, dirt or any particles which prevent a valid contact.  
Clean contacts by means of compressed air; if necessary remove dirt applying a soft abrasive movement.

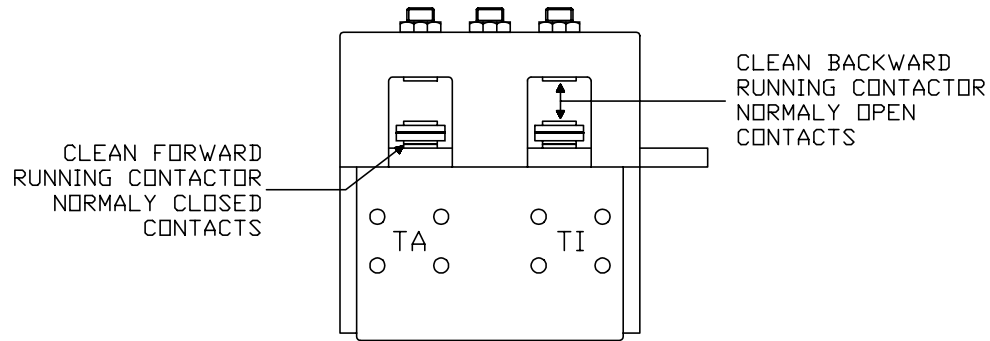

It could be necessary changing both contactors.

- A3)** It may be due to 1 of following causes of motor connecting interruption:
- brushes lift up from collector (fig.1).
  - brushes' cable burn up (fig.2).
  - Interruption either on motor winding or on motor itself cabling.
  - Error on motor cabling

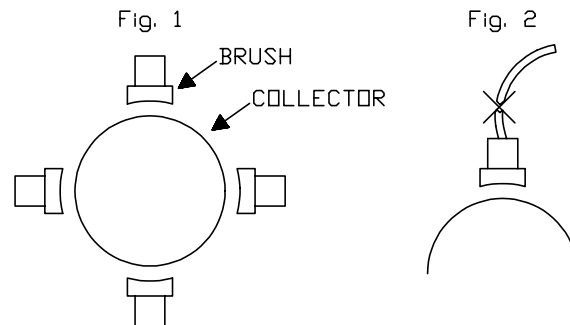

- B1)** Forward contactor (TA) is supplied with a correct voltage but it doesn't close.  
Possible causes:
- Contactor coil is interrupted, verify its resistance using an ohmmeter.
  - Contact can't move due to mechanic block.

- C1)** Supply doesn't come up to TA: check cabling and connections from TA coil to positive and to A4 (NT2).
  - C2)** Supply doesn't come up to TI: check cabling and connections from TI coil to positive and to A11 (NT1).
  - C3)** Supply comes up neither to TI nor to TA: check cabling and connections from TI coil to positive and to A4 (NT2) and to A11 (NT1).
- For points C1, C2, C3 replacing chopper may be necessary.

## **21) POSITION HANDLE**

It indicates that tiller was lowered into running position prior to key-start-up. This alarm is not activated if SAFETY SWITCH is programmed FREE.

Possible causes:

- a) tiller microswitch stuck.
- b) Operator error relating to correct sequence.

## **22) INVERSION**

It indicates that quick inversion key is being pressed at key-start-up.

Possible causes:

- a) Quick inversion microswitch stuck.
- b) Operator action error.
- c) Error either in quick inversion microswitch cabling or in programming; this alarm occurs, for example, whenever, following scheme, it's cabled to use IRZ input, while chopper is programmed for IRE or viceversa. See par 4.5 and drawings chapter 6.

## **23) FORW + BACKW**

It indicates a double running request. Possible causes:

- a) fault in cabling
- b) Operator action error.
- c) If no external irregularities are found it may be necessary to replace the chopper.

## **24) BATTERY**

It indicates that supply voltage has gone down below 60% nominal voltage.

When the alarm appears the machine doesn't move.

To start again it would be enough press again butterfly: alarm remains and the machine proceeds at 50% programmed maximum current rating.

## 6 CONNECTIONS AND CABLING DIAGRAMS

### 6.1 DIAGRAMS LEGENDA

AUX	=	Auxiliaries (loads)
AV	=	Forward
BEF	=	Electrobrake coil
BTA	=	Forward running contactor coil
BTBY	=	By-pass contactor coil
BTG	=	Main contactor coil
BTI	=	Backward running contactor coil
CH	=	Key
DF	=	Braking diode
DV	=	Flywhell diode
EV	=	Solenoid valve
IN	=	Backward
MA	=	Forward microswitch
MCL	=	Horn microswitch
MD	=	Lowering microswitch
MEF	=	Electrobrake microswitch
MI	=	Backward microswitch
MIR	=	Quick inversion microswitch
MS	=	Lifting microswitch
MSED	=	Seat microswitch
MSIC	=	Safety microswitch
MT	=	Tiller microswitch
MUM	=	Dead man microswitch
NT	=	Contactor negative
POT	=	Potentiometer
RV	=	Speed reduction
TA	=	Forward running contactor
TBY	=	By pass contactor
TG	=	Main contactor
TI	=	Backward running contactor
VMN	=	Motor negative voltage

### 6.2 COLOUR MAP

In succession you will find the decode of the colours abbreviations employed by ZAPI to

## 6.3 STANDARD H0 WITH ELECTROBRAKE

### 6.3.1 Commands connection

- MODEL:  
Standard
- OPTIONS:  
Quick inversion = OFF  
Safety switch = HANDLE  
Main cont. = BRAKE  
Motor = SERIE

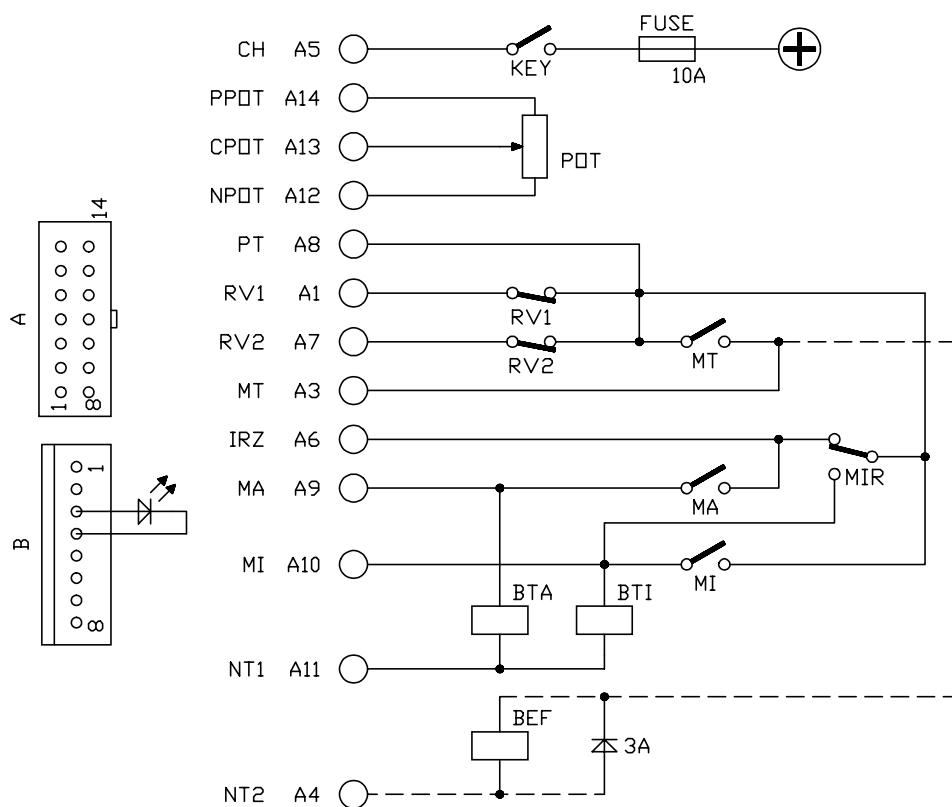

### 6.3.2 Power configuration

FUNCTIONING DIAGRAM

CABLING DIAGRAM



## 6.4 STANDARD H0 WITH BY-PASS

### 6.4.1 Commands connection

- MODEL:  
Standard
- OPTIONS:  
Quick inversion = OFF  
Safety switch = OFF  
Main cont. = BY-PASS  
Motor = SERIE

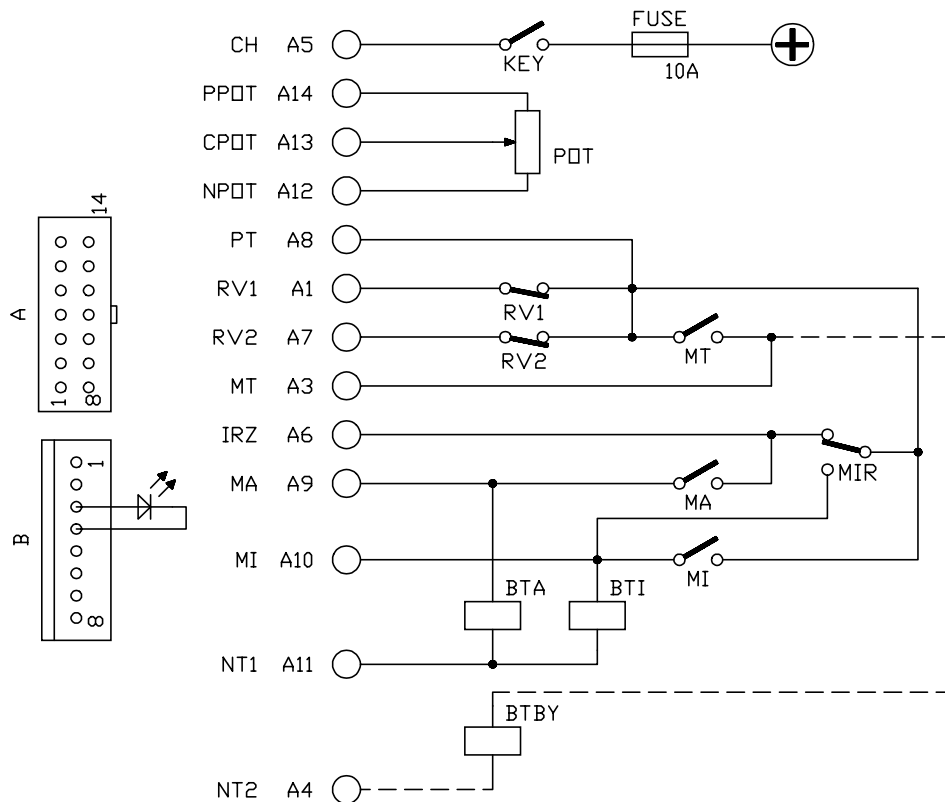

### 6.4.2 Power configuration

FUNCTIONING DIAGRAM

CABLING DIAGRAM

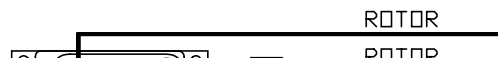
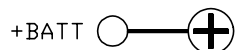

## 6.5 HO STANDARD H0 WITH GENERAL CONTACTOR

### 6.5.1 Commands connection

- MODEL:  
Standard
- OPTIONS:  
Quick inversion = OFF  
Safety switch = HANDLE  
Main cont. = GENERAL  
Motor = SERIE

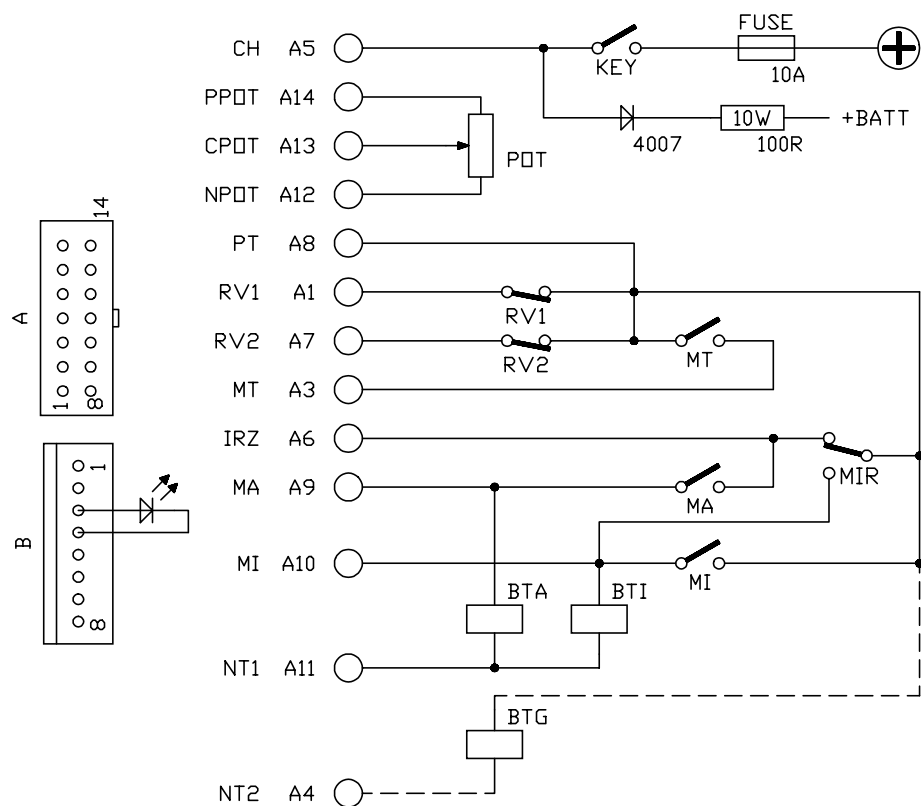

### 6.5.2 Power configuration

FUNCTIONING DIAGRAM

CABLING DIAGRAM

## 6.6 HO AUTOSTOP

### 6.6.1 Command connection

- MODEL:  
Autostop
- OPTIONS:  
Quick inversion = OFF  
Safety switch = HANDLE  
Motor = serie

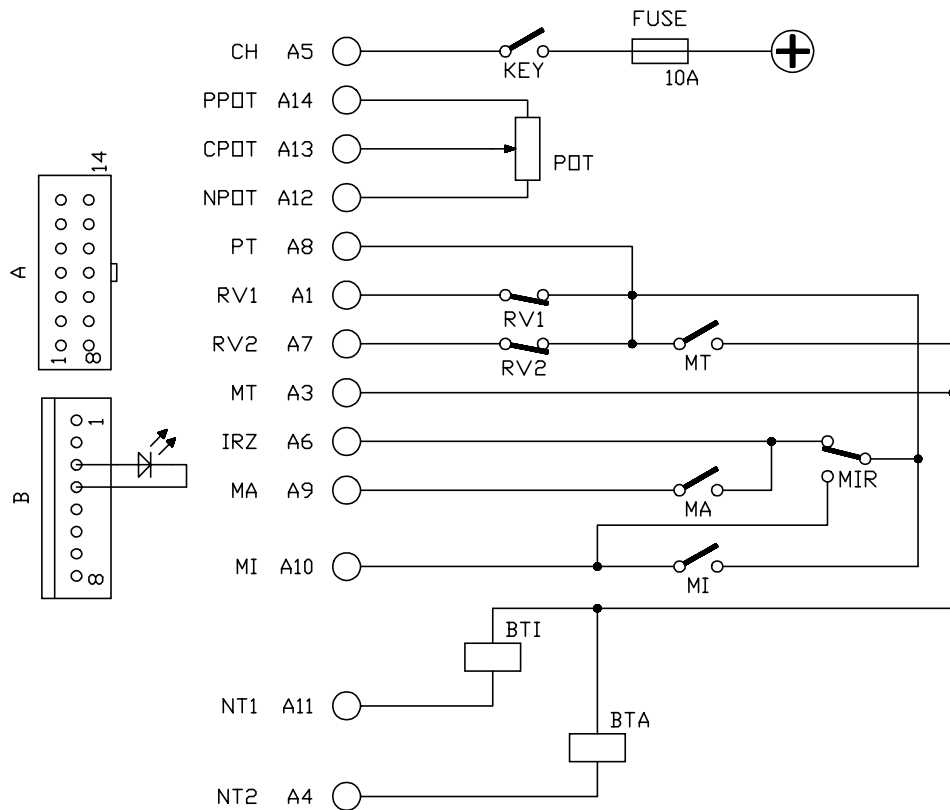

### 6.6.2 Power configuration

FUNCTIONING DIAGRAM

CABLING DIAGRAM

ROTOR

## 6.7 H0: EUROPE TYPE QUICK INVERSION CONNECTION

### 6.7.1 H0 autostop IRE

- MODEL:  
Autostop tract
- Quick inversion = ON  
Safety switch = HANDLE

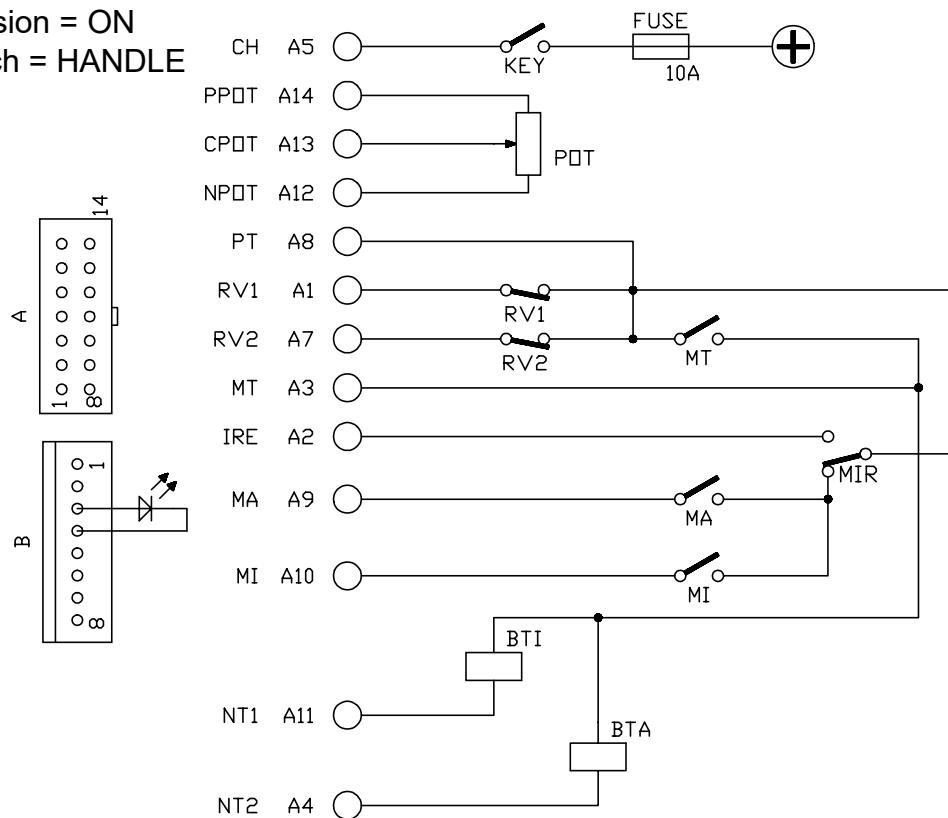

### 6.7.2 H0 standard IRE

- MODEL:  
Standard tract
- OPTIONS:  
Quick inversion = ON  
Safety switch = HANDLE  
Main cont. = FREE

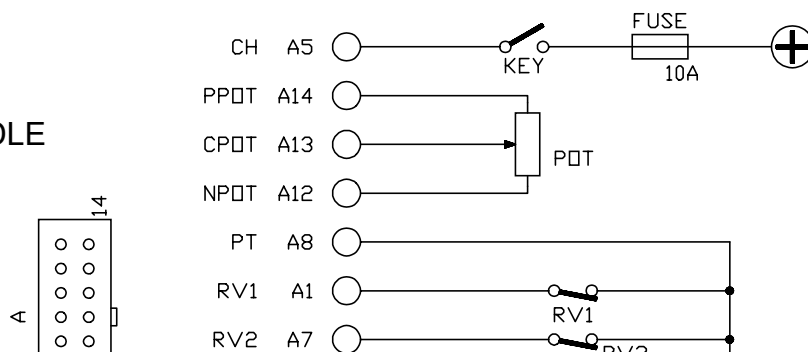

## 6.8 POWER CONFIGURATION WITH 3 CABLES SERIES MOTORS

### 6.8.1 With contactors

FUNCTIONING DRAWING

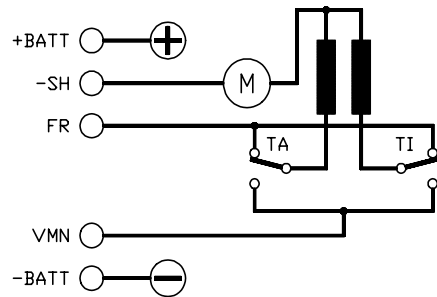

CABLING DRAWING

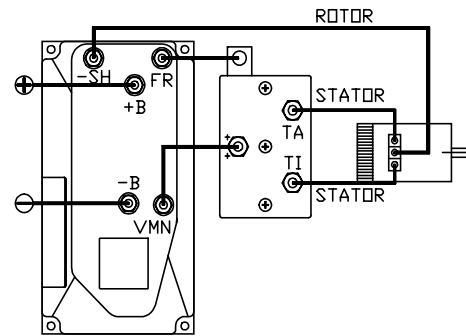

- OPTIONS:  
Motor = SERIE

### 6.8.2 With forth braking cable and standard contactors

FUNCTIONING DRAWING

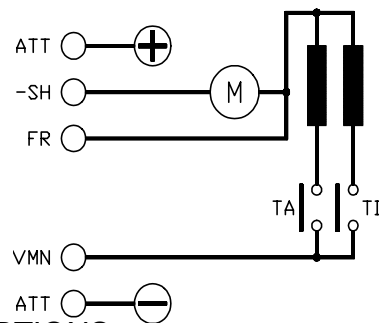

CABLING DRAWING

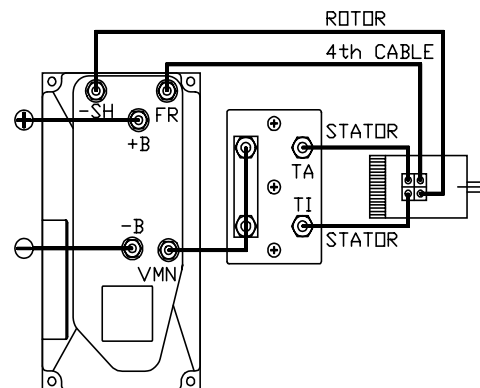

- OPTIONS:  
Motor = SERIE

## 6.9 POWER CONFIGURATIONS WITH PERMANENT MAGNET MOTORS

FUNCTIONING DRAWING

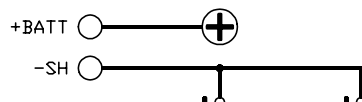

CABLING DRAWING

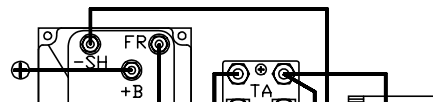

## 6.10 GUIDE DRAWING FOR PALLET TRUCKS CONNECTIONS

- Autostop configuration (IRZ)

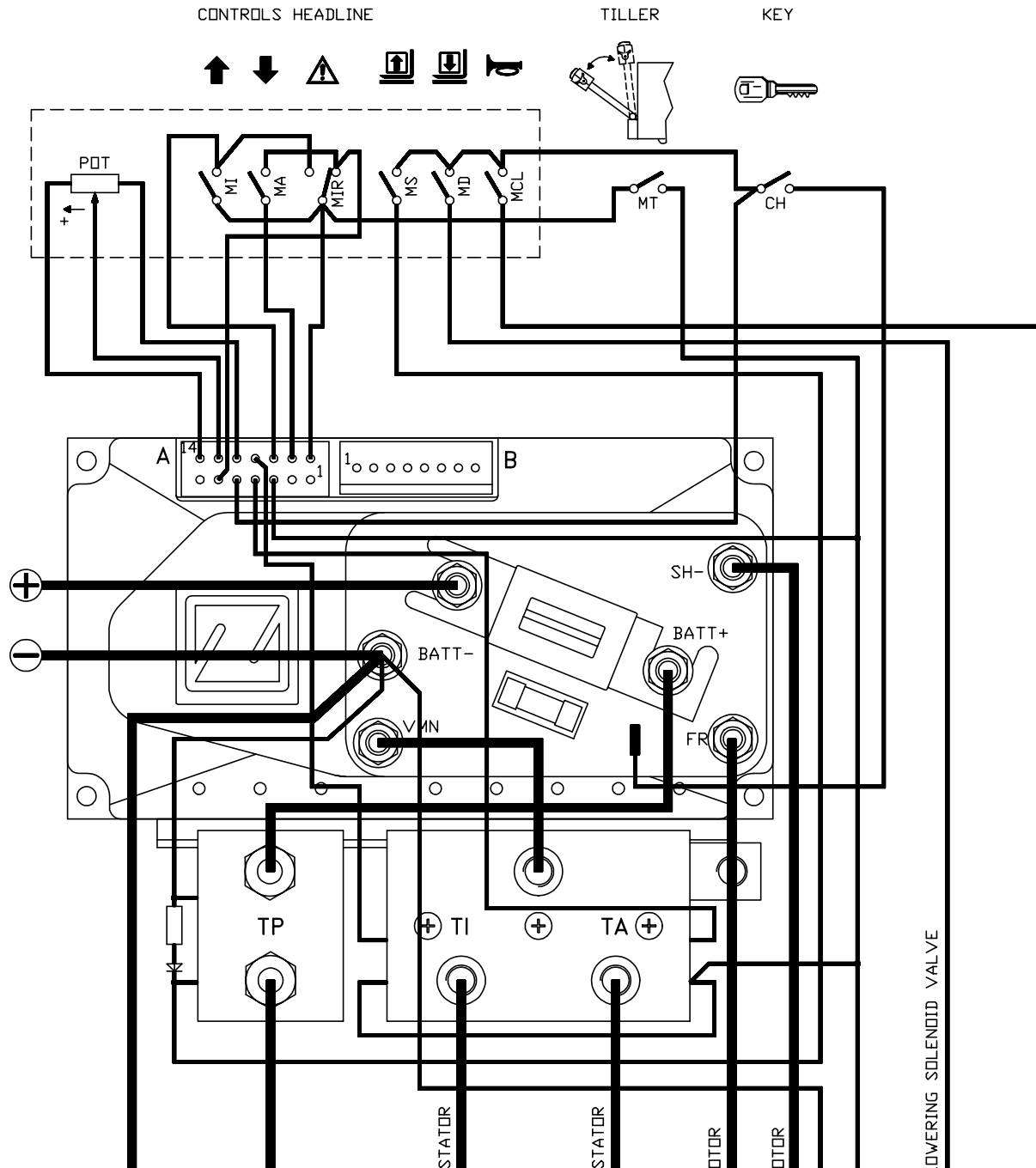

## 6.11 OPTIONAL FUSE-KEEPER BOARD

As option it's available a board that can be fitted on chopper output bars, on which power fuse (lamellar and protected) and auxiliaries fuse (5x20) are mounted. Moreover we provide a 6.3 mm faston from which positive may be taken after auxiliaries fuse.

### BOARD SCHEME

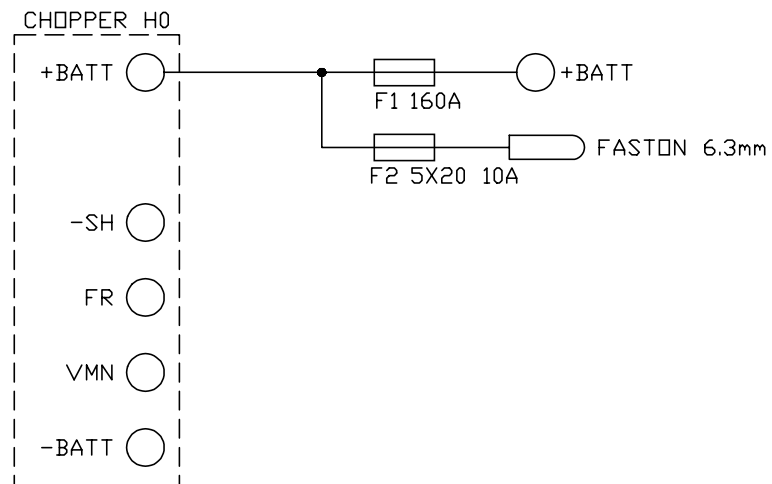

### LAYOUT SCHEME

## **7 PERIODIC MAINTENANCE TO BE REGULARLY REPEATED**

Check wear of electric contacts: they shall be replaced when matchboarding is too strong and worn-out. **Electric contacts shall be checked every 3 months.**

Check pedal microswitch: verify with a tester that there is no electric resistance between the contacts by measuring the voltage drop between its terminals. Also the release shall have a firm sound. **The pedal microswitch shall be checked every 3 months.**

Check motor-battery power connections: they shall be in excellent condition as well as the wires' claddings. **Wires shall be checked every 3 months.**

Control of the pedal and contactors springs. They shall be able to extend to its full extension and **checked every 3 months.**

Check contactors mechanical movements. They shall be frictionfree and not stuck. **Mechanical movements of the contactors shall be checked every 3 months.**

Checks shall be done only by skilled personnel and, all spare parts shall be original. Installation of this electronic controller shall be done according to the diagrams included in this manual and any variation shall be done accordingly with the supplier. The supplier is not responsible for any problem that rises from using wiring solutions different from the ones suggested on this manual.

Any cause which is visible or realizable by an ordinary technician who periodically checks the equipment, that can create damages or defects to the device shall be transmitted to the ZAPI's technician or to it's technical commercial network. They will take the responsibility for possible decisions regarding the functioning safety of the electric vehicle.



## 8 RECOMMENDED SPARE PARTS

ITEM CODE	DESCRIPTION
E07008	1 round 5 Kohm potentiometer
C22000	1 switch 10A 250V microswitch
C16502	160A protected power fuse
C16503	200A protected power fuse
C12372	FE 8 channel vol.Molex Connector
C12769	FE (Molex) rod
P99060	Red led failure indicator
C12403	FE 14 channels minifit Molex Connector
C12777	FE rod for minifit
C29548	24V SW80 Contactor
C29504	36V SW80 Contactor
C29570	24V DC88 Contactors
C29578	36V DC88 Contactors
C29517	24V SW82 Contactors
C29518	36V SW82 Contactors
	Black plastic H0 cover
	Fuse-keeper board for H0 (AB2ZPB0A)



